

CASEMENT WINDOW SERIES

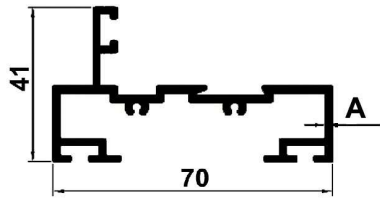

SL.NO.	SECTION NO.	A	WEIGHT(KG/M)
1	3401	1.2	0.942
2	3402	1.0	0.850

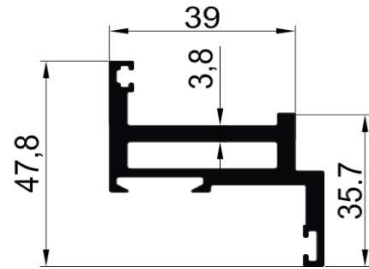

SL.NO	SECTION NO.	WEIGHT(KG/M)
1	3406	1.256

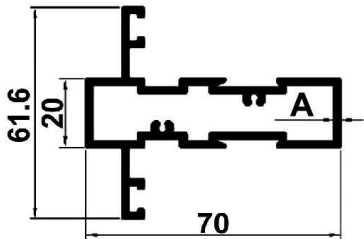

SL.NO.	SECTION NO.	A	WEIGHT(KG/M)
1	3403	1.3	0.985
2	3404	1.7	1.350

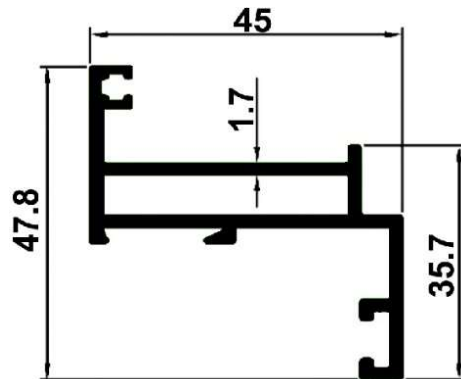

SL.NO	SECTION NO.	WEIGHT(KG/M)
1	3405	0.731

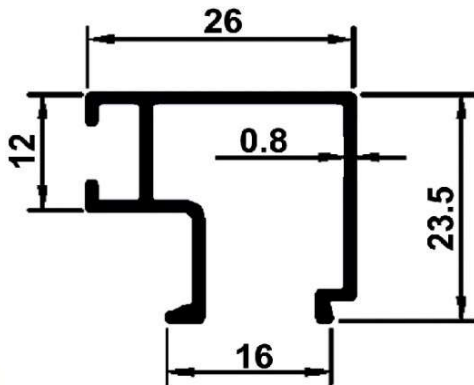

SL.NO	SECTION NO.	WEIGHT(KG/M)
1	3407	0.288

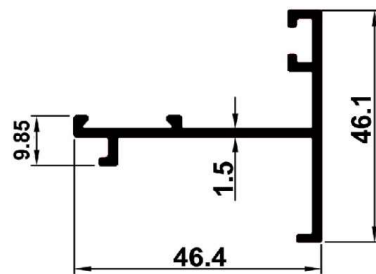

SL.NO	SECTION NO.	WEIGHT(KG/M)
1	3409	0.490

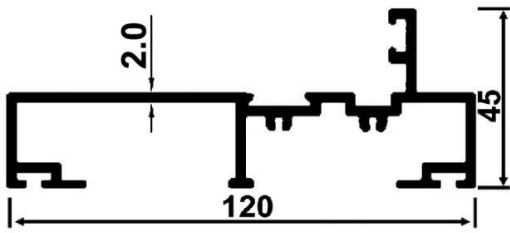

SL.NO	SECTION NO.	WEIGHT(KG/M)
1	3411	1.490

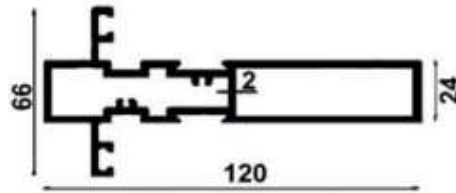

SL.NO	SECTION NO.	WEIGHT(KG/M)
1	3413	2.160

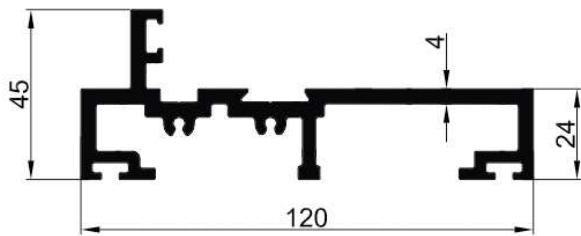

SL.NO	SECTION NO.	WEIGHT(KG/M)
1	3412	2.834

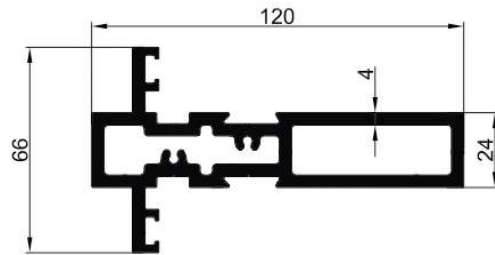

SL.NO	SECTION NO.	WEIGHT(KG/M)
1	3414	4.067

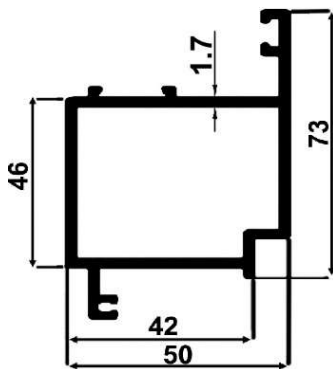

SL.NO	SECTION NO.	WEIGHT(KG/M)
1	3415	1.210

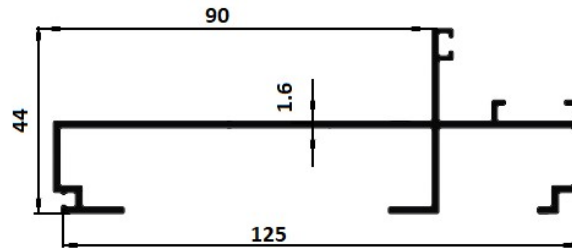

SL.NO	SECTION NO.	WEIGHT(KG/M)
1	3419	1.159

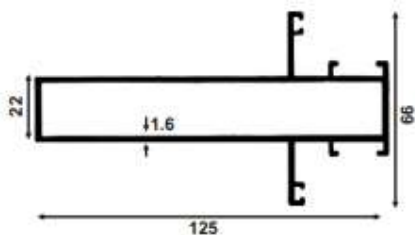

SL.NO	SECTION NO.	WEIGHT(KG/M)
1	3420	1.575

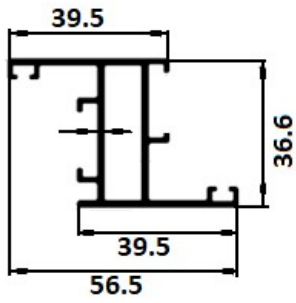

SL.NO	SECTION NO.	WEIGHT(KG/M)
1	3422	0.747

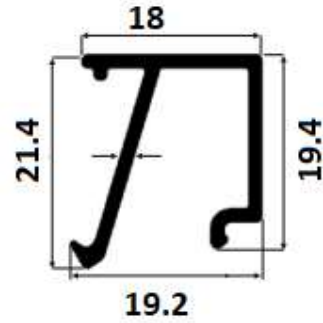

SL.NO	SECTION NO.	WEIGHT(KG/M)
1	3421	0.206

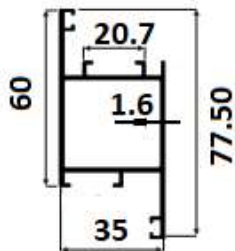

SL.NO	SECTION NO.	WEIGHT(KG/M)
1	3423	0.911

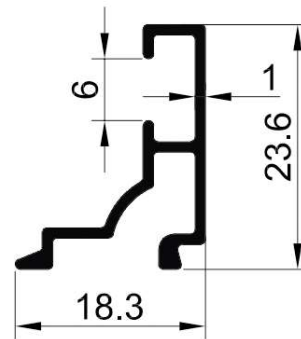

SL.NO	SECTION NO.	WEIGHT(KG/M)
1	3425	0.177

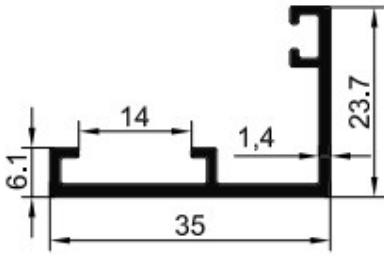

SL.NO	SECTION NO.	WEIGHT(KG/M)
1	4538	0.305

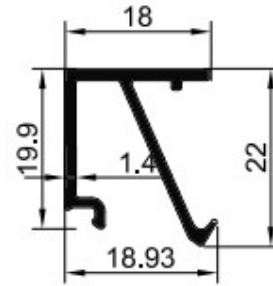

SL.NO	SECTION NO.	WEIGHT(KG/M)
1	4540	0.231

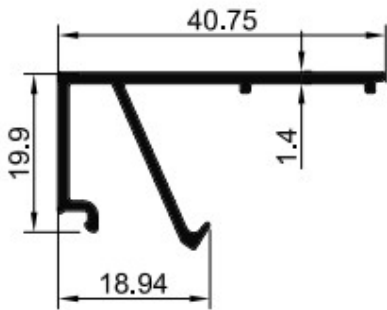

SL.NO	SECTION NO.	WEIGHT(KG/M)
1	4542	0.320

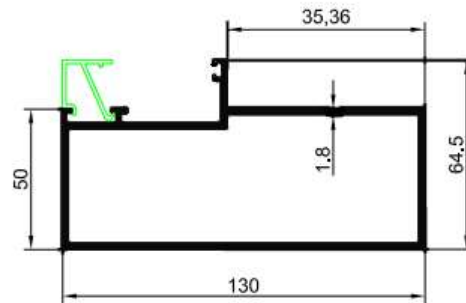

SL.NO	SECTION NO.	WEIGHT(KG/M)
1	4546	

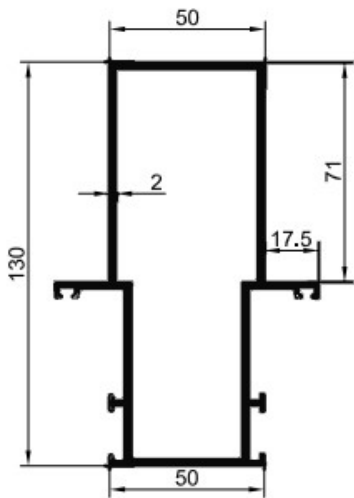

SL.NO	SECTION NO.	WEIGHT(KG/M)
1	4544	2.220

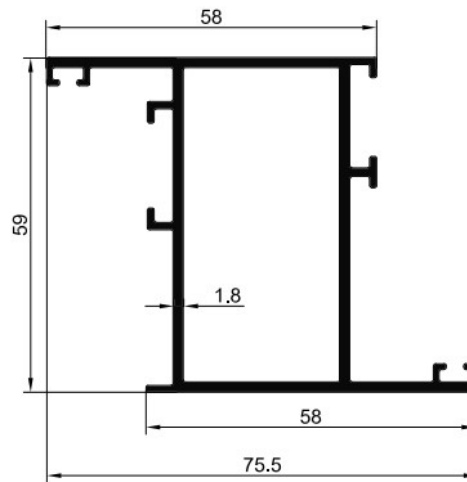

SL.NO	SECTION NO.	WEIGHT(KG/M)
1	4548	2.068

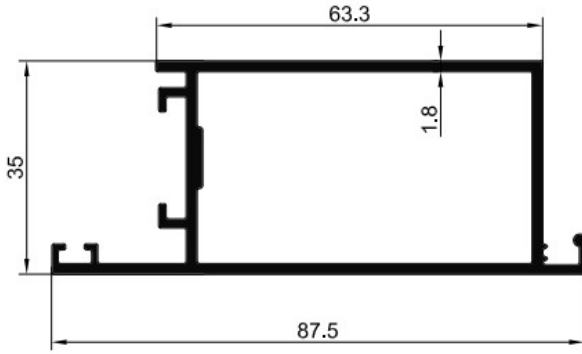

SL.NO	SECTION NO.	WEIGHT(KG/M)
1	4550	1.156

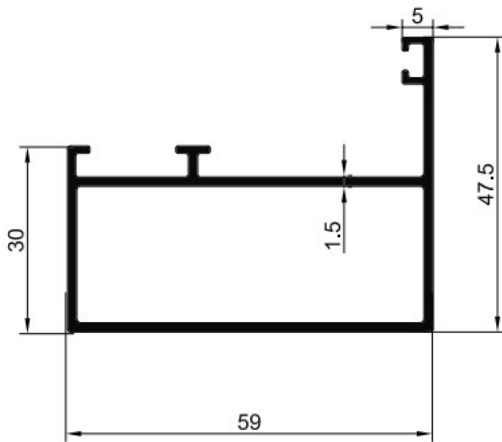

SL.NO	SECTION NO.	WEIGHT(KG/M)
1	4552	0.830